

# AQ201

# Detail Sheet



Sound Level: less than 70 db(A)  
 Normal Ambient: +5°C. - +40°C.  
 Relative Humidity: 8% - 100% non-condensing  
 Environment: clean dust free

Technical data subject to change without notice.  
 All dimensions are reference only.  
 This pump must be installed in an enclosure.  
 Solid line is 60 cycle performance.

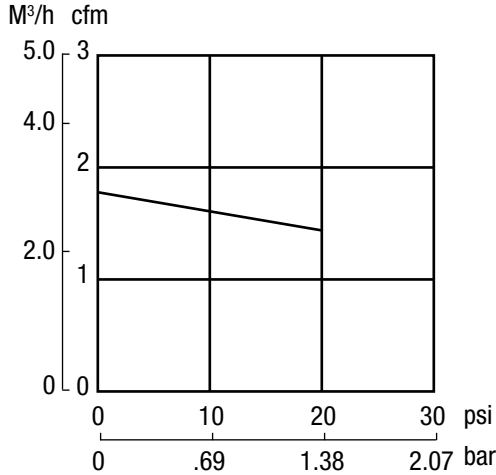

Performance Curve  
(Each Head)

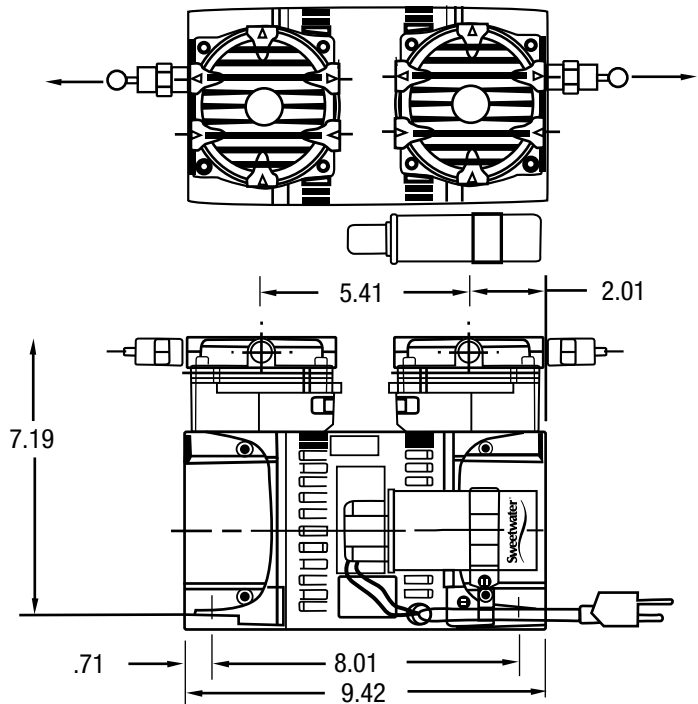
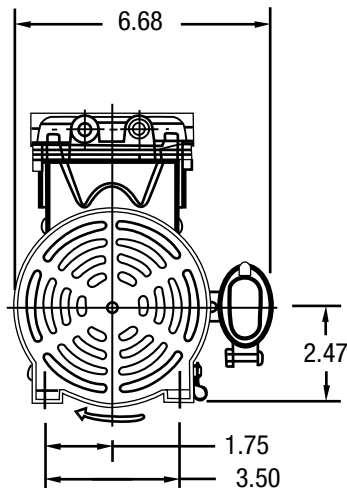
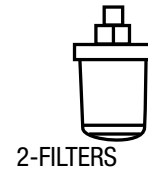

## Product Specifications

Part Number	Motor Voltage	rpm		Phase	hp	kW	Net Wt.		FLA Full Load AMPS	Capacitor mfd. - volts
		60 Cycle	50 Cycle				lbs	kg		
AQ201	115	1725	N/A	1	1/3	0.45	17.5	7.9	4.6	12.5